



Mi Robot Builder User Manual

Specs

Name: Mi Robot Builder

Age: 10 years+

Battery: Li-polymer

Input voltage: 14V

Controller: Bluetooth

Operating temperature: -10°C-45°C
(14°F-113°F)

Model: MJQR01 IQI

Materials: ABS, PC

Battery capacity: 18.315Wh

Input: 1.0A

Wireless connectivity: Bluetooth 4.0

Storage temperature: -20°C-45°C
(-4°F-113°F)

Overview

Number of pieces: 978

Weight: 2500g

Dimensions: 380x320x95mm

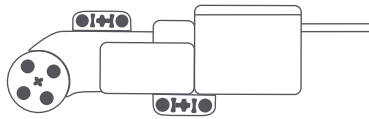

Motor 1



Controller

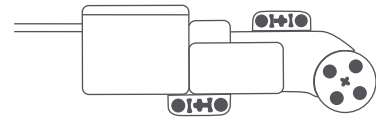

Motor 2

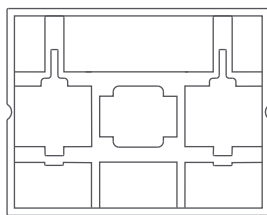

Storage box



Adapter

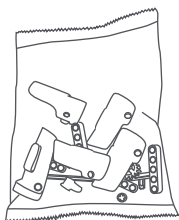

Block bags

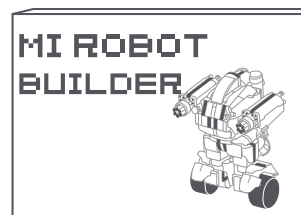

Building instruction

About Mi Robot Builder

1. Controller

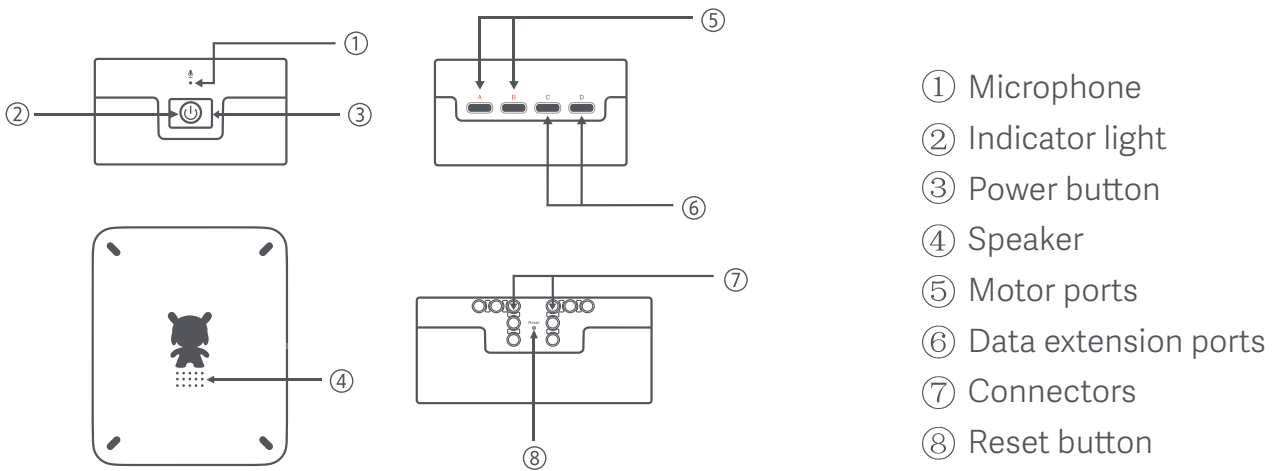

2. Adapter

Only use the power adapter that comes with your Mi Robot Builder.

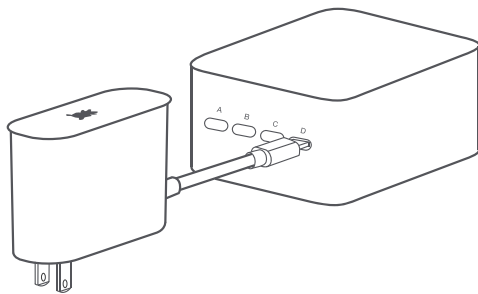

Ports A, B, C, and D can be used for charging

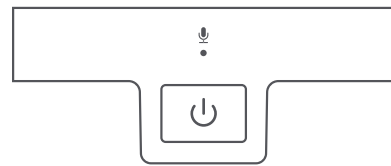

Charging: Red light

Fully charged: Green light

3. Motor

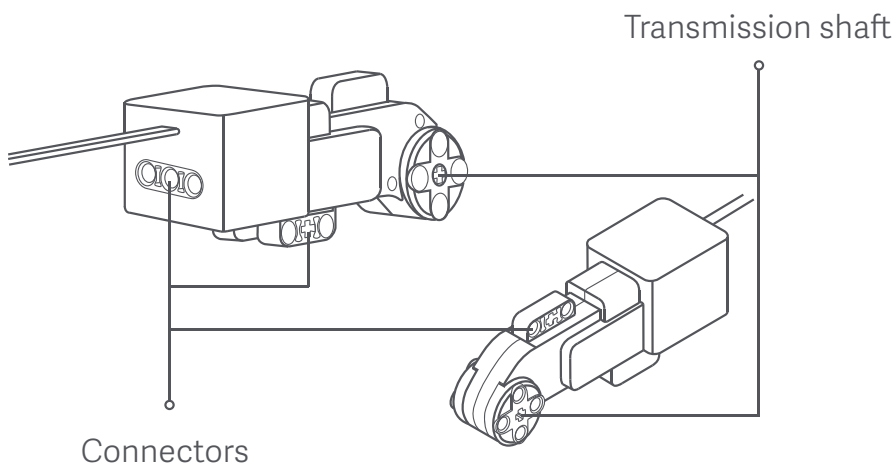

Assembling Mi Robot Builder

1. Before you start

Put smaller blocks in the storage box, and large blocks in the block bags.

2. Assembling blocks

Follow the building instruction. You can also find its electronic version in the Mi Robot Builder app.

3. Inspecting your robot

- ① Fully charge the controller when you use the robot for the first time.
- ② Make sure that the motor is connected tightly.
- ③ Mi Bunnies on the motor and the controller should be facing the same direction.
- ④ Double check if you followed the building instruction properly and didn't miss any steps.

How to turn Mi Robot Builder on

1. Choose an open level floor with enough room for your robot.
2. Place your robot on the floor vertically.
3. Press the power button. Your robot will turn on, adjust its gravity center, and balance itself.

Turning on: Press the power button.

Turning off: Press and hold the power button for 3 seconds until you hear a sound prompt.

Note: Make sure your robot stands vertically. It may fall on its side while adjusting its gravity center. Users can lightly hold the robot to avoid falling down.

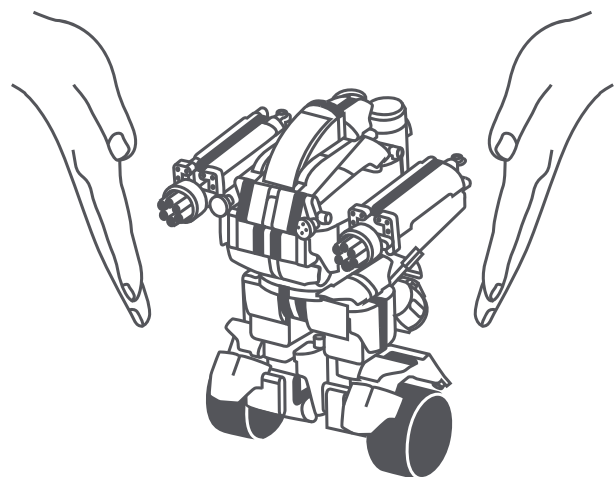
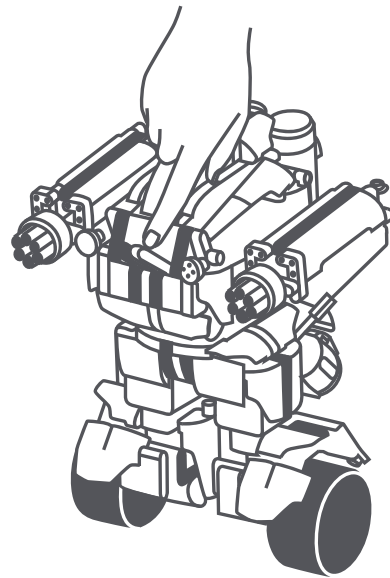

Installing the app

1. Search for "Mi Robot Builder" in your preferred app market or scan the QR code to download the app.



2. Connecting your robot

Turn on Bluetooth of your phone, open the Mi Robot Builder app, tap the Bluetooth icon in the upper left corner, and connect your robot.

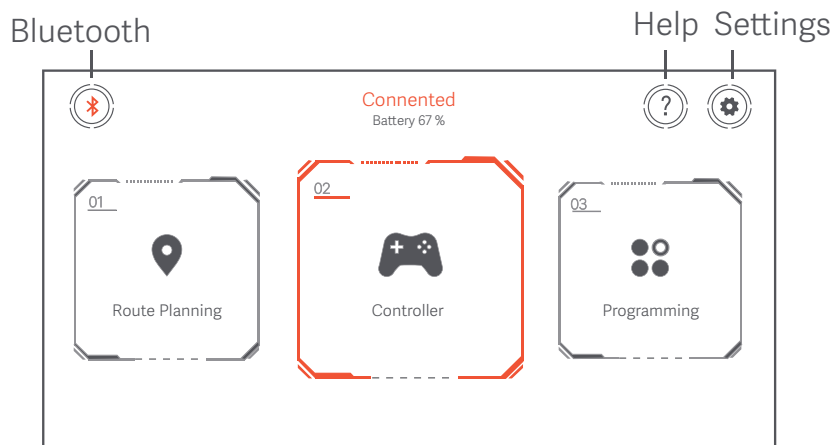

3. Firmware updates and support

Make sure your phone is connected to the internet (preferably via Wi-Fi). Open the app and connect to your robot.

Tap Settings → System updates → Firmware updates

It takes about 20 minutes to update the firmware. Here are the things you should remember during the update:

- ① The motor shouldn't be working during updates; otherwise, some parameters may be overwritten, which may result in misbehavior.
- ② The controller should be fully charged before an update.
- ③ Your phone should be close to the controller throughout the update.
- ④ View "Help" in the app to learn more.

FCC Statement

This device complies with Part 15 of the FCC Rules. Operation is subject to the following two conditions:

- (1) This device may not cause harmful interference, and
- (2) This device must accept any interference received, including interference that may cause undesired operation.

Attention that changes or modification not expressly approved by the party responsible for compliance could void the user's authority to operate the equipment.

Note: This product has been tested and found to comply with the limits for a Class B digital device, pursuant to Part 15 of the FCC Rules. These limits are designed to provide reasonable protection against harmful interference in a residential installation. This product generates, uses, and can radiate radio frequency energy and, if not installed and used in accordance with the instructions, may cause harmful interference to radio communications. However, there is no guarantee that interference will not occur in a particular installation. If this product does cause harmful interference to radio or television reception, which can be determined by turning the equipment off and on, the user is encouraged to try to correct the interference by one or more of the following measures:

- Reorient or relocate the receiving antenna.
- Increase the separation between the equipment and receiver.
- Connect the equipment into an outlet on a circuit different from that to which the receiver is connected.
- Consult the dealer or an experienced radio/TV technician for help.

This equipment should be installed and operated with a minimum distance 20cm between the radiator and your body.



Troubleshooting

Issues	Possible reasons	Solutions
Power button doesn't respond	The controller's battery is low	Charge the controller
Can't connect via Bluetooth	The controller is off	Turn the controller on
	Your phone's Bluetooth is off	Turn on Bluetooth on your phone
Indicator light turns red after a firmware upgrade and an error sound prompt is played	Bluetooth disconnected	Connect via Bluetooth again
	The controller's battery is low	Charge the controller
Can't run the program	Bluetooth disconnected	Connect via Bluetooth again
	You haven't tapped the Start button in the app	Tap the start button
The indicator light doesn't turn red when charging	The power adapter isn't connected properly	Connect the power adapter properly
The robot can't balance itself	The motor isn't connected properly	Connect the motor to the port A or B
	The motor isn't connected tightly	Make sure the motor is tightly connected
	The motor is installed in the wrong direction	Make sure the direction of the motor is consistent with the controller
	The controller's battery is low	Charge the controller
The robot walks shakily	The robot isn't assembled properly	Read building instruction to make sure you've assembled the robot properly
Can't use the app to control the robot	Bluetooth disconnected	Connect via Bluetooth again
Can't charge	You're using an incompatible power adapter	Use a compatible power adapter

Press the Reset button if you can't solve the issues using the solutions above.

Safety precautions

- ① Avoid disassembling the controller and the motor.
- ② Avoid exposing the toy to sunlight, fire, heat or temperatures above 60°C/140°F.
- ③ Do not short circuit.
- ④ Avoid any mechanical impact.
- ⑤ Children under 10 years old must be accompanied by adults.
- ⑥ This product is not suitable for children under three years old. Choking hazard. Toy contains small parts.
- ⑦ The controller must be turned off when it is charging.



Principal: Xiaomi Communications Co., Ltd.

Manufacturer: Beijing AIOI Technology Co., Ltd.
(a Mi Ecosystem Company)

Address: Room 1203, Block D, Jinyu Jiahua Mansion, No.9 Shangdi 3rd St.,
Haidian District, Beijing China, 100085

Thank you for choosing Mi Robot Builder!
Read this manual carefully before using the product.
Do not throw this manual away.